

User Manual

Intelligent Digital Manifold



MS-2000



MS-4000

CONTENTS

1. Preface and Precautions	1
2. Product Profile	2
3. Specifications	5
4. Quick Start Guide	6
5. Interface Details	15
6. Help	16

1. Preface and Precautions



1.1 Preface

Thank you for purchasing Elitech MS series intelligent manifold gauge. Elitech digital manifold MS series are not consumer products. Only qualified personnel trained in service and installation of A/C and/or refrigeration equipment shall use this product.





Read and understand this user manual in its entirety before using your manifold to prevent injury or damage to you or equipment.



1.2 Precautions



Descriptions

-  Incorrect operation may cause serious injury.
-  Incorrect operation may cause minor injury.
-  Incorrect operation may damage the device.

Caution

-  This product is not suitable for maintenance of ammonia (ammonia-containing) refrigerant system.
-  This product contains batteries. Do not place the product in a high temperature environment or place in a fire. Otherwise, it will explode.
-  Do not use this product during thunderstorm to avoid being stuck by lightning causing life danger and product damage.
-  Strictly obey the safety cautions of the refrigeration system.

-  Please put on goggle and protective gloves while using the product. Please read the maintenance instruction of the system unit carefully before connecting the device to the system.
-  Please contact us in time if the product is damaged. Do not dismantle the product on your own to avoid further damage to the product that might cause batteries fire or explosion.

-  When using other power adapters, the output voltage must not exceed 5V, otherwise the instrument will be damaged.
-  The magnet embedded at the back of the product is to position the folded hook. Do not try to attach the product to any metal surface to avoid the product from falling and damage.

Environmental Protection

Please comply to local environmental protection policies. Refrigerants should not be directly discharged to the atmosphere and must be recycled with professional equipment.

At the end of the product service life, please recycle it according to the local regulations. Do not dispose randomly to avoid environmental pollution.

2. Product Profile

2.1 Products Introduction

MS series of intelligent manifold gauge integrates the functions such as pressure and temperature measurement, pressure holding measurement, vacuum measurement, refrigerant weight measurement and data logging. It is suitable for daily inspection and maintenance of HVAC/R system.

- Simple & easy operation with 5" smart touch screen, clear data display.
- Support App Operation by the Bluetooth, data view and analysis in real time.
- Support USB to read and export data.
- Auto heat pump mode without changing the refrigerants hoses.
- Detect the vacuum leakage, monitoring the vacuum value precisely.

⚠ The refrigerant weight measurement function work with Elitech refrigerant electronic scales. Please purchase the scale separately if necessary.

2.2 Product Overview



MS-2000 Product Details

- | | |
|---|---|
| 1. High temperature clamp sensor interface (with sealed plug) | 8. 5 inches IPS capacitive color touch screen |
| 2. Low temperature clamp sensor interface (with sealed plug) | 9. Sight window |
| 3. Type-C power interface (with sealing plug) | 10. Low pressure refrigerant pipe interface (1/4 SAE port) |
| 4. Power button | 11. High pressure refrigerant pipe interface (1/4 SAE port) |
| 5. High pressure control valve | 12. Refrigerant charging interface (1/4 SAE port) |
| 6. Low Pressure Control Valve | 13. Refrigerant pipe bracket |
| 7. Metal handles | |



MS-4000 Product Details

1. High temperature clamp sensor interface (with sealed plug)	9. Sight window
2. Low temperature clamp sensor interface (with sealed plug)	10. Low pressure refrigerant pipe interface (1/4 SAE port)
3. Type-C power interface (with sealing plug)	11. High pressure refrigerant pipe interface (1/4 SAE port)
4. Power button	12. Refrigerant charging interface (1/4 SAE port)
5. High pressure control valve	13. Vacuum refrigerant pipe interface (3/8 SAE port)
6. Low Pressure Control Valve	14. Vacuum control valve
7. Metal handles	15. Charging control valve
8. 5 inches IPS capacitive color touch screen	16. Refrigerant pipe bracket



Accessories

1. Temperature clamps	3. Transmitter T-joints
2. Vacuum transmitter	4. Transmitter bending joint

3. Specifications

3.1 Manifold

Pressure measurement range	-14.5~800psi/-1.0~55.2bar/-0.1~5.5MPa/-1.0~56.2kg/cm ²
Accuracy	0.5%FS
Resolution	0.5psi/0.03bar/0.003MPa/0.03kg/cm ²
Sampling frequency	0.5s
Pressure unit	psi、kg/cm ² 、cmHg、inHg、bar、kPa、MPa
Overload	1000psi/69bar/6.8MPa/70kg/cm ²
Pressure interface	1/4SAE*3 3/8 SAE*1 (MS-4000)
Sensor interface	PS/2*2(the left interface is temperature and vacuum probe multiplexing)
USB Interface	Type-C*1(for data export and charging)
Charging parameter	5V2A
Battery capacity	5000mAh
Recording time	800h(Interval time 30s)
Screen parameter	5"IPS capacitive touch screen
BLE distance	30m
Dimensions	254*215*46mm (MS-2000) 254*215*71mm (MS-4000)
Weight	3.5lb /1.59kg (MS-2000) 3.8lb /1.73kg (MS-4000)
Working temperature	-14~122°F/-10~50°C
Storage temperature	-4~140°F/-20~60°C

! Data export via USB cable connected to a computer.

3.2 Vacuum

Vacuum measurement range	1-19000 microns
Accuracy	1-10000 microns: ±10% of reading / ±10 microns 10000-19000 microns: ±20% of reading
Resolution	0-400 1 micron 400-3000 10 microns 3000-10000 100 microns 10000-19000 250 microns
Vacuum unit	micron、inHg、Torr、psia、mbar、mTorr、Pa、kPa
Interface	1/4SAE port



3.3 Temperature Clamp

Temperature Measurement Range	-40~302°F/-40~150°C
Accuracy	±0.9°F/±0.5°C
Resolution	0.2°F/0.1°C
Temperature unit	°F/°C/K
Interface	PS/2

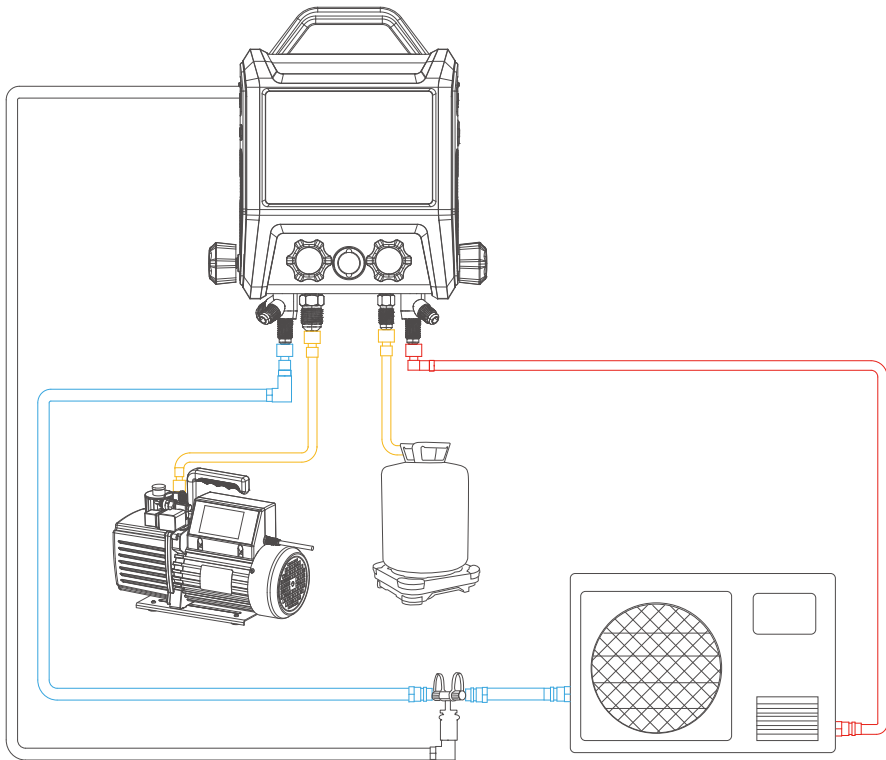
4. Quick Start Guide





4.1 Pressure and Temperature Measurement (for charging, recovery, maintenance monitoring, etc.)



1. Press the power button to turn on and enter the main menu.
2. Connect the high and low pressure temperature clamp on both sides of the mainframe and clamp the temperature sensor to measure the temperature of the corresponding system.
3. Connect the high pressure and low pressure interface of the system to the corresponding interface of the instrument.
4. Click on the  to enter the pressure temperature measuring interface.
5. Select the refrigerant by  R134a.
6. Choose the corresponding working mode according to the current system, usually is the refrigeration mode.
7. After the setup is done, you may check the accurate status of the system through the interface.

 Only selected refrigerant scale models can support the manifold, please check with the seller for details.

4.2 Pressure Holding Measurement

1. Fill the system with appropriate amount of nitrogen.
2. Close the High-Pressure Side Valves.
3. Connect the measured system to the high pressure side of the instrument.
4. Click the  to enter the pressure-holding test.
5. Click the  and set the desired parameters.
6. Press the  to enter the pressure-holding test.

4.3 Vacuum Measurement

1. Connect vacuum transmitters to the system and connect communication cable to the manifold.
2. Open the low-pressure side and high-pressure side valves. (applicable to MS-2000, MS-4000 series).
Open the low-pressure side, high pressure side valve, vacuum valve, and close the charging valve. (applicable to MS-4000 series).
3. Click the  to then enter the vacuum interface and set the desired value and working time.
4. Turn on the vacuum pump and pump to the set value.
5. Click the  to set the alarm.
6. Close all valves.
7. Click the  to enter the leak test.

5. Interface Details

5.1 Main Interface



This is the main interface display once the device is turned on. There are “Pressure and Temperature Measurement”, “Pressure Holding Measurement”, “Evacuation Measurement”, “Electronic Refrigerant Scale” and “Setting” for selection. Click on the icon to enter each of the corresponding functions. The status bar on top of the page displayed the time, power/ battery indicator, wireless connection and recording status.

Icon instructions

 Bluetooth has been turned on	 Record function has been turned on
 Bluetooth has been turned off	 Record function has been turned off

5.2 Setting Interface

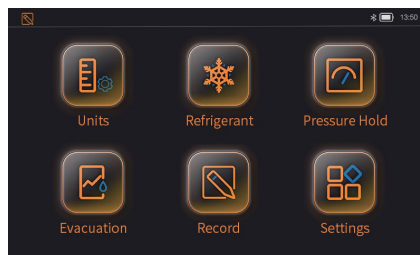

The setting interface includes “Unit Settings”, “Refrigerant Selection”, “Pressure Holding Setting”, “Evacuation Setting”, “Record Setting”, “System Setting”. Click the icon to enter the corresponding setting page.

5.2.1 Unit Settings

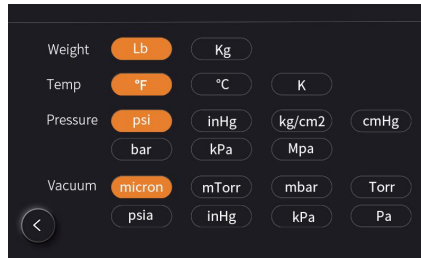

The unit of weight, temperature, pressure and vacuum can be set. Click  to go back to the previous page. The parameters are saved automatically.

5.2.2 Refrigerant Selection

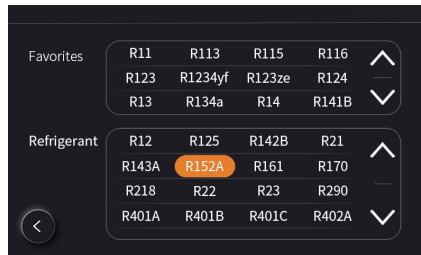

User may select the desired refrigerant from the refrigerant selection box. The selected refrigerant will be added to Favourites automatically. Maximum 20 refrigerant can be added.

 If the number exceeds 20, the earliest refrigerant will be replaced with the latest refrigerant that has been selected.

5.2.3 Pressure Holding Settings

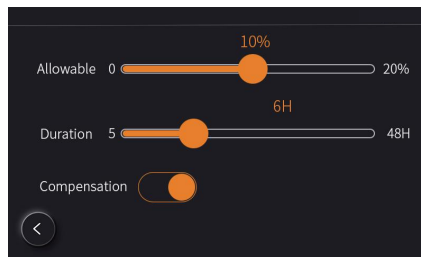

Pressure decay ratio, pressure holding time and temperature compensation can be set in this page. Click  to go back to the previous page. The parameters are saved automatically.

5.2.4 Evacuation Settings



The alarm and duration for refrigerant leak can be set. Click  to go back to the previous page. The parameters are saved automatically.

5.2.5 Record Settings

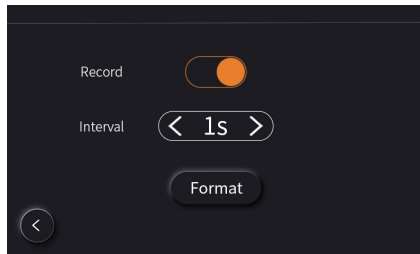



User may enable/disable recording, recording interval and clear record history in this page. Press the “Format” button to clear the record history.

 *The recording will stop automatically when it reaches the maximum capacity. Please export the data in time and clear the record history.*

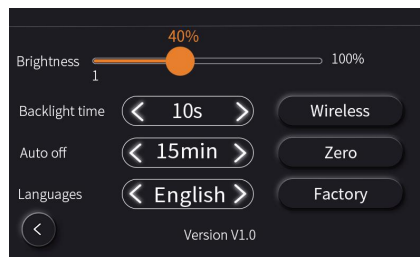
5.2.6 System Settings





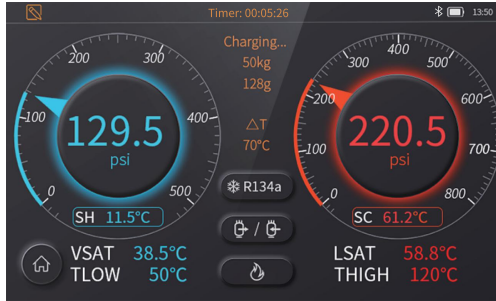

User may set the backlight brightness, backlight time, system auto shutoff and system language in this page. Press  to enter next page to enable/disable Bluetooth. Press  to zero off the high and low pressure. Press  to factory reset.

 *Please place the device in the atmospheric environment while calibrating.*

5.3 Pressure and Temperature Measurement



Icon Instruction

Icon display status	Instruction
 Selected refrigerant	 Refrigerant scale setting
 Refrigeration mode	 Heat pump mode
 Automatic mode	

The timer on the status bar on top starts timing automatically once user enter this page. The purpose is to record the time user spend on this page.

Choose the right refrigerant first to avoid affecting the temperature calculation. Click  to select the desired refrigerant. The selected refrigerant will be shown on the icon.

The pressure and temperature measurement interface measure and display the pressure for low-pressure side, the corresponding evaporation saturation temperature, low pressure pipeline temperature and superheat as well as the pressure for high-pressure side, the corresponding condensation saturation temperature, high pressure pipeline temperature and supercooling. Other than these, the difference temperature of the low-pressure pipe and high-pressure pipe, charging/recovery weight value can be measured and displayed as well.

There are three measurement modes in page: refrigeration mode, heat pump mode and automatic mode.

Refrigeration mode: This is the regular mode.

Heat pump mode: VSAT parameters and LSAT parameters will be switching display position.

Automatic mode: The display position of the corresponding parameters will be switching automatically when the pressure of the low-pressure side is 1 bar higher than the high-pressure side.

Switching Between Dial Mode and Curve Mode

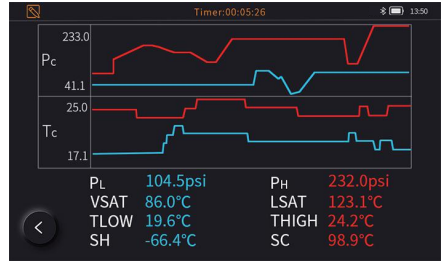

Simply click on the middle of the dial meter to switch to curve mode. Click to switch back to dial mode.

Charging and Recovery Function

Shows the current status and weight, press to enter the charging and recovery settings page.

After the setting is done, click to save the setting and return to the pressure temperature measurement page.

There is no weight display if the current device is not connected to the refrigerant scale.

5.4 Pressure Holding Measurement

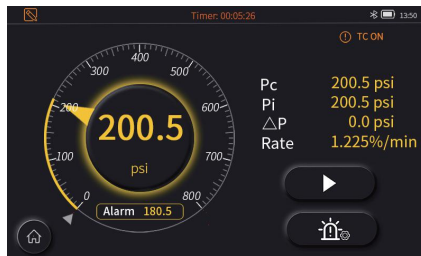

- The timer on the status bar on top starts timing automatically once user enter this page. The purpose is to record the time user spend on this page.
- indicate the temperature compensation has been enabled or disable. It can be set in the pressure-holding settings interface.
- Temperature compensation enabled: The device will monitor the current ambient temperature in real time to reduce the pressure variation error that caused by the change of the ambient temperature.
- Temperature compensation disabled: Device calculate based on the measured pressure.
- Click to set decay ratio and pressure-holding time and choose if to enable or disable the temperature compensation based on the actual situation.
- Click to start the pressure-holding test. The countdown timer starts to elapse according to the duration that has been set. During the process, the device calculates the pressure variants and the deflation rate automatically based on the current and initial value. The test failed if the current value is less than the alarm value; the test passed if the current value is greater than the alarm value and exceed the pressure-holding duration.

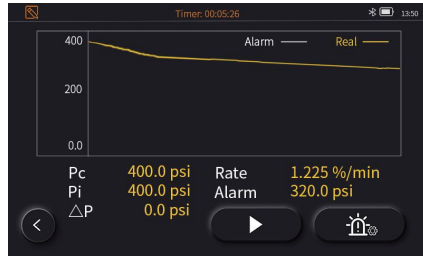

Switching Between Dial Mode and Curve Mode



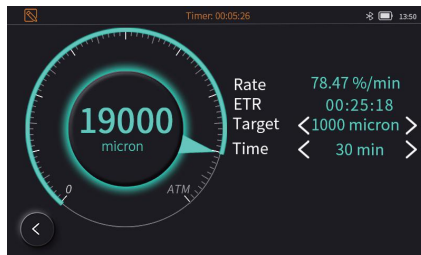

Simply click on the middle of the dial meter to switch to curve mode. Click  to switch back to dial mode.

5.5 Vacuum Measurement



- The timer on the status bar on top starts timing automatically once user enter this page. The purpose is to record the time user spend on this page. The “Start” and “Alarm Setting” button is not displayed yet.
- Click  or  to select the preset vacuum target value. The device calculates the remaining time based on the targeted value and rate.

 *The remaining time rest is for reference only.*

- Working time: It is to set the current vacuum duration. The alarm goes off if the duration has exceeded without achieving the targeted value.
- If the duration is not exceeded and the targeted value is reached, it prompts that the leak test can be performed.
- The “Starts” and “Alarm Settings” are displayed now.
- Click  to enter the alarm setting interface
- Click  to enter leak test based on the alarm setting value. The parameters displayed in the vacuum interface will be switched to speed, test duration and alarm value. During the leak test duration, if the leakage is greater than the set alarm value, the leak warning will be prompted. Otherwise, the test is passed.

Switching Between Dial Mode and Curve Mode

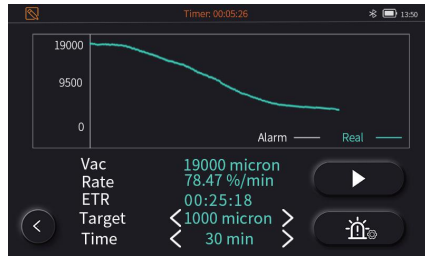

Simply click on the middle of the dial meter to switch to curve mode. Click ◀ to switch back to dial mode.

- ! 1. This function has to work with the vacuum transmitter. Please plug the transmitter to the socket at the left of the device.
- 2. The timer on the status bar will be reset if the Working Time was re-set.

5.6 Refrigerant Electronic Scale

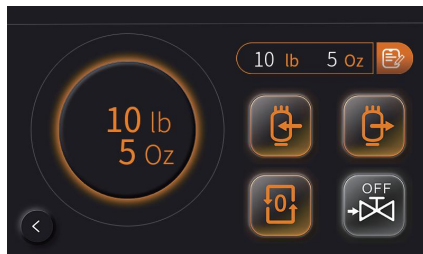

- The timer on the status bar on top starts timing automatically once user enter this page. The purpose is to record the time user spend on this page.
- ! This function works only if device connected with the refrigerant scale. It is to control and set up the scale.
- Reset button, to reset the current weight.
- Set to Charging mode
- Set to Recovery Mode
- To manually control the solenoid valve to be opened or closed. The OFF/ON button on the icon indicates the current status of the solenoid valve.
- ! This function is only available for the scale that includes a solenoid valve.
- The solenoid valve automatically shuts off when the charging/recovery amount reaches the set target value.
- **10 lb 5 oz** Displays the last set charging or recovery value.

Charging and recovery settings

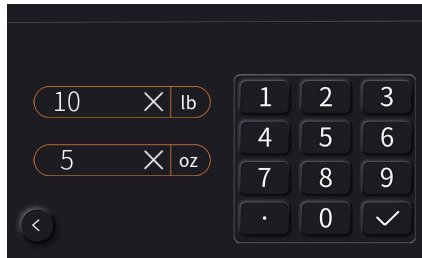

Press  to enter the charging/recovery setting interface

The 2 groups of units: lbs and oz, kg and g.

Choose the units and click to enter the weight, click  to save. Click  to delete and reset the value.

Press the Return key, the charging/ recovery setting is completed.

 *Min weight: 1.4 oz.*

Max weight: the maximum measured weight of the current refrigerant scale.

5.7 APP QR Code



 *Please check the APP operation instructions in Help.*

5.8 Parameters

Parameter	Description
SH	Superheating
VSAT	Vapor saturation temperature
TLOW	Temperature of low side
SC	Subcooling
LSAT	Liquid saturation temperature
THIGH	Temperature of high side
ΔT	TLOW-THIGH
Factory	Factory reset

Parameter	Description
TC ON	Temp compensation enable
TC OFF	Temp compensation disable
TC	Temp compensation
ETR	Estimated time remaining
Pc	Current pressure
Pi	Initial pressure
ΔP	Pc-Pi

6. Help

6.1 Troubleshooting

Problem	Possible causes/solutions
Failed to turn on device	Connect the device to the charger and try to turn it on after 5 minutes.
Touch screen doesn't work	Make sure the environment temperature is within the working temperature range (-14~122°F/-10~50°C).
The measured temperature shows "----"	Check if the temperature clamp is fully connected or if the measuring temperature is out of the measurement range.
Pressure zone display "E02"	Pressure uncalibrated
The pressure value shows large error	Please place the device in the atmospheric environment to calibrate zero.
Vacuum display "----"	The system has a large leak, or the vacuum transmitter data is abnormal.
No response after clicking the interface button	System crashes. Long press the Power button for 7s to restart the system.

6.2 Operation and Maintenance

1. Storage: It is recommended to store the fully charged device or disconnect the battery if not using it frequently.
2. Cleaning: Please wipe the device with a damp cloth, Do not wash it directly.
⚠ *Note: Do not use any corrosive solvents!*
3. Keep the connectors clean and remove the surface dirt regularly.
4. Check the device for any leaks regularly. It is recommended to check once a year.

6.3 Accessories

Product and Accessories	Quantity
MS-2000/MS-4000 intelligent manifold gauge	1
Vacuum transmitter (T-joint)	1
Temperature clamp	2
Bent joint	1
Refrigerant Hoses	3(MS-2000) 4(MS-4000)
Power adapters	1
USB-C Cable	1
Instructions	1